

Article number: 391804407042210

Description: Worm gear with st. steel hollow shaft  
VF 44 EP-F2-70- 63B5

## Measures

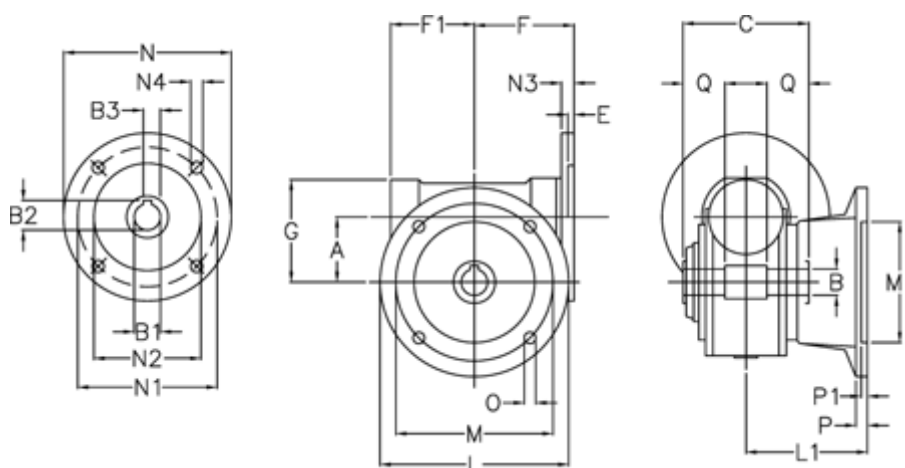

a	= 44.6	F1 = 54	N2 = 95
B	= 18	g = 71	N3 = 10.5
B1 E7	= 11	L = 110	N4 = 9.5
B2	= 12.8	L1 = 60.5	O = 8.5
B3 H9	= 4	m = 87	P = 9
C	= 64	M1 = 60	P1 = 7
E	= 2.0	N = 140	Q = 24.5
F	= 65	N1 = 115	